



**SAFE AND SECURE**



*A complete line of side folding grilles and solid closures provide security and access control in low headroom conditions.*

# *Side Folding Grilles and Closures*

## Side Folding Grille: VisionGlide™ Model ESG-30

An effective traffic barrier that allows high visibility. With a hang weight of 0.8 lbs. per square foot, VisionGlide is an ideal solution to install on limited supporting structures. The curtain is formed with a series of vertical 5/16" diameter aluminum rods on 3.5" centers. Horizontal chains formed of eyeletted aluminum links are spaced at 12" apart. Vertical hanger rods mounted to rollers that slide in the overhead track support the curtain. Excellent for floor to ceiling dividers in public spaces such as offices, hospitals and lobbies.

### VisionGlide™ Standard Features:

- Clear anodized rods, links and post material
- PVC Tube Spacers, Polycarbonate Hinged Top and Bottom Panels to Match
- Fully Anodized Version Optional
- Maximum Height: 12' 0"
- Clear anodized finish
- 12" Link Spacing Standard
- 9", 6" or 3" Spacing Optional
- Hook bolt locking with cylinders both sides standard, other locking optional
- 14" radius 90° and 135° curves standard, others optional.
- See back for additional Design Construction Details.

### Curtain Patterns:

- VisionGlide™ Straight
- VisionGlide™ Brick

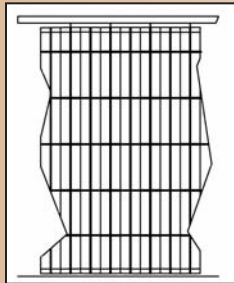

ESG-30 VisionGlide™  
Straight

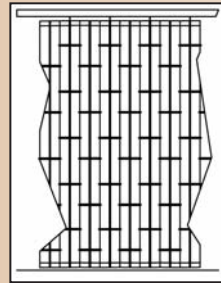

ESG-30 VisionGlide™  
Brick



## Side Folding Grille: GlideGard™ Model ESG-32

Heavy duty construction provides a higher level of security. Individual panels interlock by full height hinge members. Fully concealed hinge rods protect from vandalism. Recommended for use behind storefront glass and where high strength with ventilation is required: food courts, schools, sports complexes and public transit.

### GlideGard™ Standard Features:

- Clear Anodized Rods, Links, Post Material and Hinged Top and Bottom Panels.
- PVC Tube Spacers to Match
- 12" Link Spacing Standard
- 9", 6" or 3" Spacing Optional
- Maximum Height: 14' 0"
- Color Anodizing Optional. Custom Paint - consult factory.
- Hook bolt locking with cylinders both sides standard, other locking optional
- Emergency Egress Option- bi-part or full 3' x 7' egress door within the curtain
- 14" radius 90 and 135° curves standard, others optional.
- Fully Anodized Version Optional
- See back for additional Design Construction Details.

### Curtain Patterns:

- GlideGard™ Straight
- GlideGard™ Brick

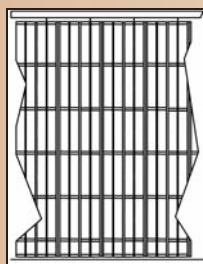

ESG-32 GlideGard™  
Straight

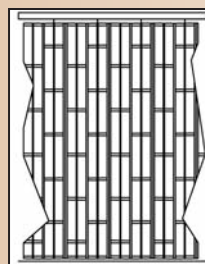

ESG-32 GlideGard™  
Brick



# Side Folding Closure: VistaPane™ Model ESC-31

## VistaPane™ Standard Features:

- Clear Anodized Truss Panels and Posts
- Color Anodizing, Custom Paint - consult factory
- Hook bolt locking with cylinders both sides standard, other locking optional

- Emergency Egress Option- Bi-part or full 3' x 7' egress door within the curtain
- 14" radius 90 and 135° curves standard, others optional
- See back for additional Design Construction Details.



Optional Emergency Egress Door Shown

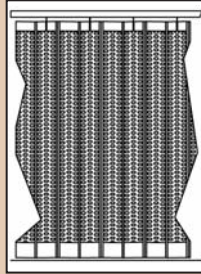

ESC-31 VistaPane™  
Slotted Aluminum

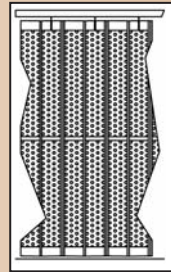

ESC-31 VistaPane™  
Perforated Steel

## Slotted and Perforated Panels:

Perforated with a pattern of slots that provides high level security with visual access and air flow. Interlocking components prevent forced entry. Lighter than glass inserts; requiring less bulkhead support and easy to operate. Excellent for storefront applications.

### ■ VistaPane™ Slotted

- 13 Gauge Fully Anodized Slotted Aluminum Panels
- 1 1/4" x 1/4" oblong slots
- Extruded insert fits into framing hinge extrusion for superior security
- Maximum Height: 20' 0"
- Airflow Through Closure: 20%
- Airflow Through Panel: 30%

### ■ VistaPane™ Perforated

- 3/16" Perforated 18 Gauge Steel Panels
- Maximum Height: 14' 0"
- Airflow Through Closure: 39%
- Airflow Through Panel: 47%

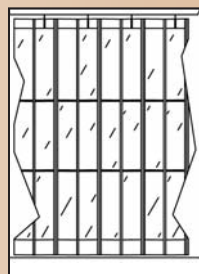

ESC-31 VistaPane™  
Glass or Lexan

## Glass and Lexan Panels:

Clear, shatterproof Lexan® or tempered glass inserts allow unobstructed views while providing solid security and blocking refuse, odor and smoke.

### ■ VistaPane™ Lexan

- 1/8" Thick Lexan Panels
- Maximum Height: 14' 0"

### ■ VistaPane™ Glass

- Clear Tempered Glass Panels
- Maximum Height: 12' 0"

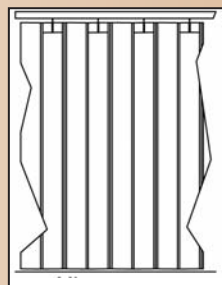

ESC-31 VistaPane™  
Solid

## Solid Panels:

Full height aluminum panels and heavy gauge dedicated extrusions deny visual access and provide solid security.

### ■ VistaPane™ Solid

- 13 Gauge Clear Anodized Solid Aluminum Panels
- Maximum Height: 20' 0"

# Side Folding Grille Details

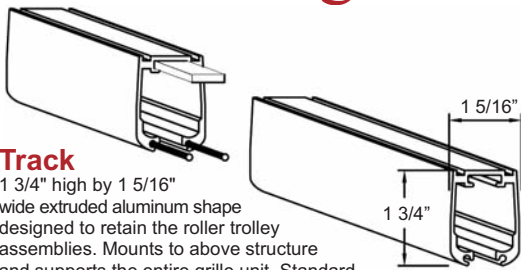

## Track

1 3/4" high by 1 5/16" wide extruded aluminum shape designed to retain the roller trolley assemblies. Mounts to above structure and supports the entire grille unit. Standard curves are 90 or 135 degree with a 14" radius. Custom angle and radius curves are available.  
**Standard Material & Finish:** clear anodized aluminum

## Pocket

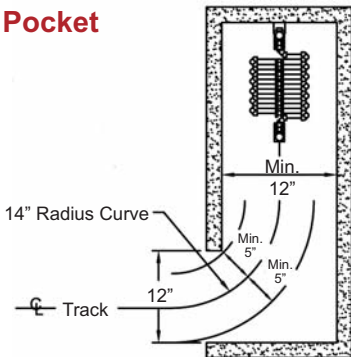

## Section

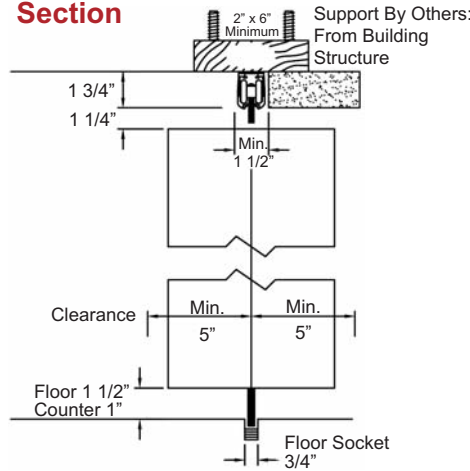

## Minimum Stacking

1.05" per Foot of Opening + 3.5" per post, or Approximately 2" per Foot of Opening

# Design Construction Details

- Minimal headroom required - A 1 3/4" high by 1 5/16" wide track mounts to overhead structure to support the unit.
- No floor track is required.
- Maximum recommended width of a single unit section is 30' 0" (before using a bi-parting unit).
- Maximum intermediate member spacing is 13' for full height units, 7' for countertop units.
- Operation is manual push / pull only.
- Minimum height for all units is 2' 0", minimum width for all units is 4' 0".
- Maximum height: see below.
- The grille support should be designed to carry the weight of a fully stacked door at any point along its length. See below.

	Maximum Height	Lbs. Per Sq. Ft.
VisionGlide	12' 0"	0.8
GlideGard	14' 0"	1.5
VistaPane Perforated	14' 0"	2.0
VistaPane Slotted	20' 0"	2.2
VistaPane Lexan	14' 0"	2.25
VistaPane Glass	12' 0"	2.5
VistaPane Solid	20' 0"	2.25

# Vertical Upright Members

2 3/8" x 1 5/16" tubular extruded aluminum sections

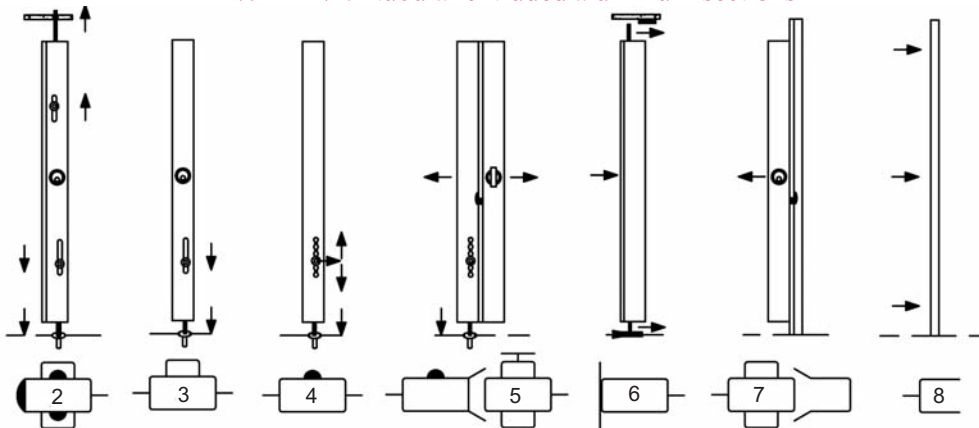

## Top & Bottom Locking End or Intermediate

Located at the beginning of a curtain or curtain section, these members contain a top and bottom drop bolt lock for engagement at the floor and ceiling.

## Bottom Locking Intermediate: Cylinder Control Spring Knob

Located throughout the curtain so that any open section does not exceed 13'. These members have a drop bolt lock for engagement at the floor.

## Bi-Part

Located at all curtain bi-part sections, these members have an attached strike channel for matching up with a lead member and a drop bolt lock for engagement at the floor.

## Floating End

With an attached full height protection plate and located within a stack pocket, these members float from the back to a set minimum projection in the pocket being stopped by track and floor mounted stoppers.

## Hookbolt and Wall Striker

These members join a wall or member mounted strike channel and contain a hook bolt lock that engages the strike channel.

## Fixed End

Normally used on grilles with exposed stacking, these members are set up with a full height wall mounting plate or angle for direct attachment to the wall.

# Special Feature Options

- Pocket Door - Available option for side folding grilles to neatly finish off pocket openings. Both the pocket door and frame are made of heavy duty 12 gauge steel that is coated with a baked-on polyester powder coat finish. Available up to 12' in height and fit pocket openings from 10" to 24" wide.
- Multiple Height Units - Available for openings that have a full height and a countertop area. This is accommodated with a bi-part unit or with a single pocket unit when the pocket is located at the full height side of the opening.



# Optional Finishes

For standard clear anodized components:

- Color Anodized: medium bronze, dark bronze or champagne
- Custom Wet Paint: consult factory

**CORNELL**  
SAFE AND SECURE

An ISO 9001:2008 Registered Company

Crestwood Industrial Park • Mountaintop, PA 18707 • TEL 800.233.8366 • FAX 800.526.0841

Architect & Design Support Dept.: Ext. 4551 • Email: ADS@cornelliron.com

Website: [www.cornelliron.com](http://www.cornelliron.com)



239-768-3667

239-643-3667

800-375-3667

[www.ActionDoor.com](http://www.ActionDoor.com)